

COD. 500001268 REV 1

**ACERBIS PARTS**

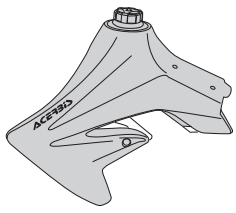

**A - (1 pcs.)**



**B - (2 pcs.)**



**D - (1 pcs.)**



**C - (2 pcs.)**



**E - (1 pcs.)**

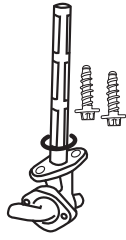

**H - (2 pcs.)**

**O.E.M ITEMS TO USE:**



**I - (2 pcs.)**



**F - (1 pcs.)**



**G - (1 pcs.)**

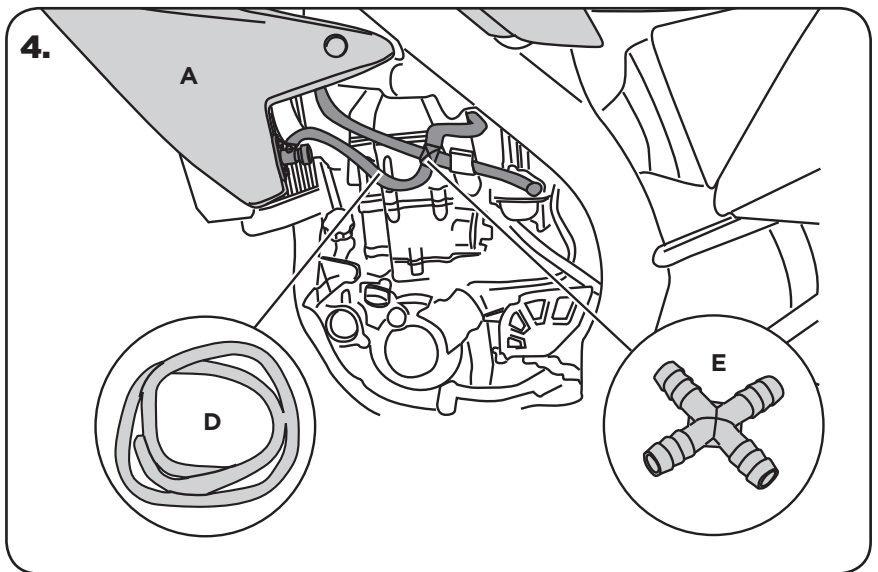
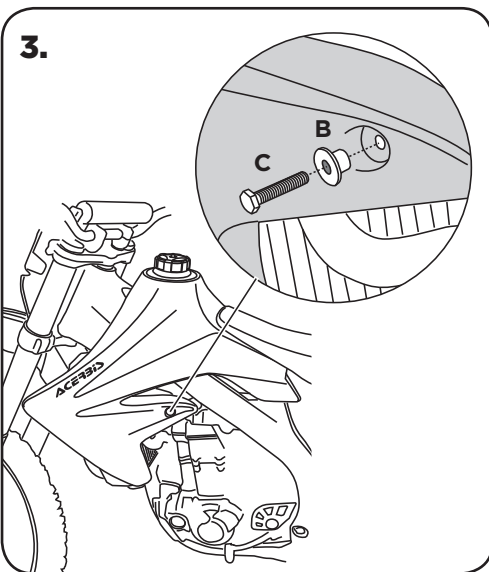
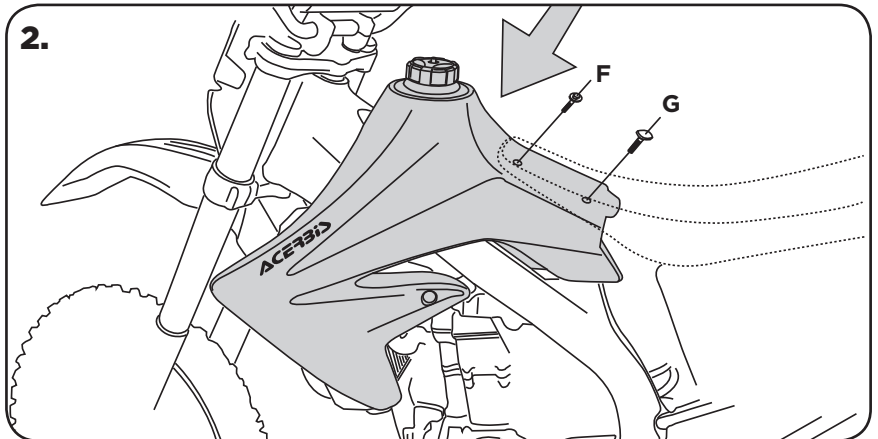
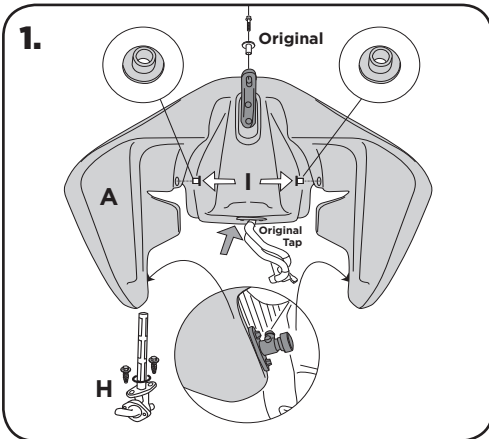
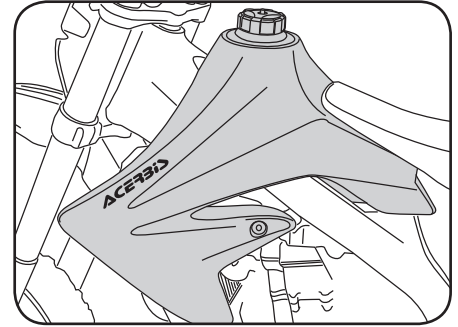

**WARNING!**

Clean tank interior thoroughly before installation. install this fuel tank only in a well ventilated area, as gasoline fumes are extremely dangerous. do not start operate the vehicle if there are any fuel leaks! acerbis recommends that installation be done by licensed mechanic. read all instructions first before beginning installation.

**ATTENZIONE!**

Pulire a fondo l'interno del serbatoio prima dell'installazione. svolgere l'operazione unicamente in un ambiente ventilato, poiche' i fumi della benzina sono estremamente pericolosi. non avviare il veicolo se si riscontrano perdite di carburante! acerbis raccomanda l'installazione presso meccanici autorizzati. leggere attentamente le istruzioni prima di iniziare il montaggio.

**DISCLAIMER:**

DISCLAIMER: Due to uncontrolled variables in the manufacturing process of rotationally molded fuel tanks, the fuel tank may vary in size and shape by up 7% of the manufacturer's original listed capacity.

**LIBERATORIA**

LIBERATORIA: A causa di variabili inponderabili nel processo di stampaggio rotazionale dei serbatoi, questi possono differire in forma e dimensioni fino al 7% rispetto alla capacità dichiarata.

**FOR COMPETITION USE ONLY  
SOLO PER USO AGONISTICO**

**ACERBIS®**

SOUL AND PASSION

**Thank you** for purchasing an ACERBIS fuel tank

## WARNING

It is **EXTREMELY IMPORTANT** that the fuel tank be properly installed. To ensure proper installation, it is **STRONGLY RECOMMENDED** that the tank be installed only by a qualified OEM licensed dealership mechanic. Improper installation could result in serious injury or even death.

**If self-installed NOTE THE FOLLOWING.** Particular attention must be paid to excessive fuel line length and fuel line proximity to hot engine areas and pipes to prevent fire.

Clean tank interior thoroughly before installation. Install this fuel tank only in a well ventilated area, as gasoline fumes are extremely dangerous. Do not start or operate the vehicle if there are any fuel leaks! Read all instruction first before beginning installation.

## DISCLAIMER

Due to uncontrolled variables in the manufacturing process of rotationally molded fuel tanks, the fuel tank may vary in size and shape by up to 7% of the manufacturer's original listed capacity.